

BROEN-LAB

Drejervaenget 2, 5610 Assens, Denmark

Phone: +45 6376 6376

E-mail: lab@broen-lab.com

Web : broen-lab.com





























FITTINGS FOR WATER

Premium range

99B0048 Rev. 2 - 04.03.2024

TABLE OF CONTENTS

BROEN-LAB UniFlex™					Page 3
Configuration overview					Page 4
					
Bench mounted fitting with swivel spout <i>Page 6</i>	Bench mounted fitting on a column <i>Page 7</i>	Bench mounted two valve fitting on a U-shaped column <i>Page 8</i>	Bench mounted two valve fitting on a T-shaped column <i>Page 9</i>	Bench mounted fitting on a column with swivel spout <i>Page 10</i>	
					
Bench mounted three valve fitting <i>Page 11</i>	Bench mounted hands-free SensorTap <i>Page 12</i>	Wall mounted fitting 90° valve <i>Page 13</i>	Wall mounted fitting straight valve <i>Page 14</i>	Wall mounted fitting with swivel U-spout <i>Page 15</i>	
					
Wall mounted fitting with swivel U-spout <i>Page 16</i>	Wall mounted 90° valve with rear wall connection (RWC) <i>Page 17</i>	Wall mounted straight valve with rear wall connection (RWC) <i>Page 18</i>	Wall mounted fitting with swivel U-spout and rear wall connection (RWC) <i>Page 19</i>	Wall mounted 90° fitting for exposed piping or built-in installation <i>Page 20</i>	
					
Wall mounted straight fitting for exposed piping or built-in installation <i>Page 21</i>	Suspended fitting with two 90° valves <i>Page 22</i>	Bench mounted two handle one hole mixer with swivel spout <i>Page 23</i>	Bench mounted one handle one hole mixer <i>Page 24</i>	Bench mounted one handle one hole BioLab mixer <i>Page 25</i>	
					
Bench mounted one handle one hole mixer <i>Page 26</i>	Bench mounted one handle one hole mixer with hand shower <i>Page 27</i>	Bench mounted two handle two hole mixer on columns with swivel spout <i>Page 28</i>	Bench/Wall mounted two handle two hole mixer with swivel spout <i>Page 29</i>	Wall mounted two handle two hole mixer with swivel spout <i>Page 30</i>	
					
Wall mounted one handle two hole mixer with swivel spout <i>Page 31</i>					
BROEN-LAB UniFlex™ hoses for water					Page 32
Headworks					Page 34
Accessories					Page 35
Ordering information					Page 38

BROEN-LAB UNIFLEX™ METAL HANDLE

THIS IS BROEN-LAB UNIFLEX™ PREMIUM

BROEN-LAB UniFlex™ Premium line offers a very high quality and durability combined with the complete program, which adds up to low LCC (Life Cycle Costs). Our Metal Handle line takes the standards in the market to a higher level.

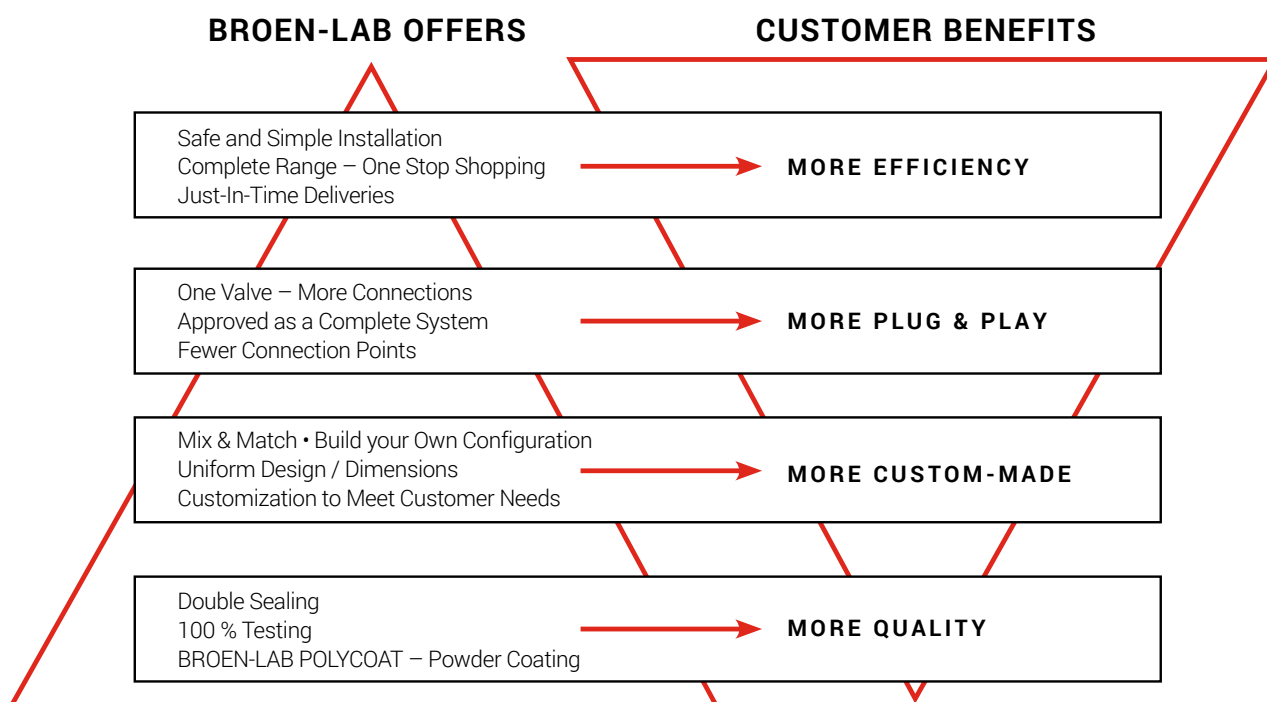

BROEN-LAB UniFlex™ Premium fittings for water are designed for laboratory use. The operation and the configuration of the fittings are highly adapted to the requirements of a modern laboratory. The fittings are surface treated with BROEN-LAB POLYCOAT powder coating, which is highly resistant to most chemicals, UV fading and heat (for more information please refer to "BROEN-LAB POLYCOAT" brochure.)

Most water fittings are as standard delivered with a removable hose nozzle with a loose union nut which offers quick and effortless assembly and disassembly when a hose has been fixed to the nozzle.

As an option it is possible to get water fittings with integrated check valve, which prevent backflow.

BROEN-LAB UniFlex™ Premium for water incorporate a BALLOFIX® ball valve (where relevant), which offers a number of advantages such as local shut-off (e.g. in connection with product service) and pre-setting for experimental purposes.

THIS IS BROEN-LAB UNIFLEX™

BROEN-LAB UniFlex™ is a unique and patented connection, which allows customers to choose from various connection methods, such as hoses, Cu, PEX or Stainless Steel pipes, without changing the valve itself. It provides unique flexibility, not only for the installer, but also for the end-user. Due to the flexibility of the system, the quick installation and savings on fittings, this system offers lower TIC (Total Installed Costs).

PRODUCT OVERVIEW

WATER TAP

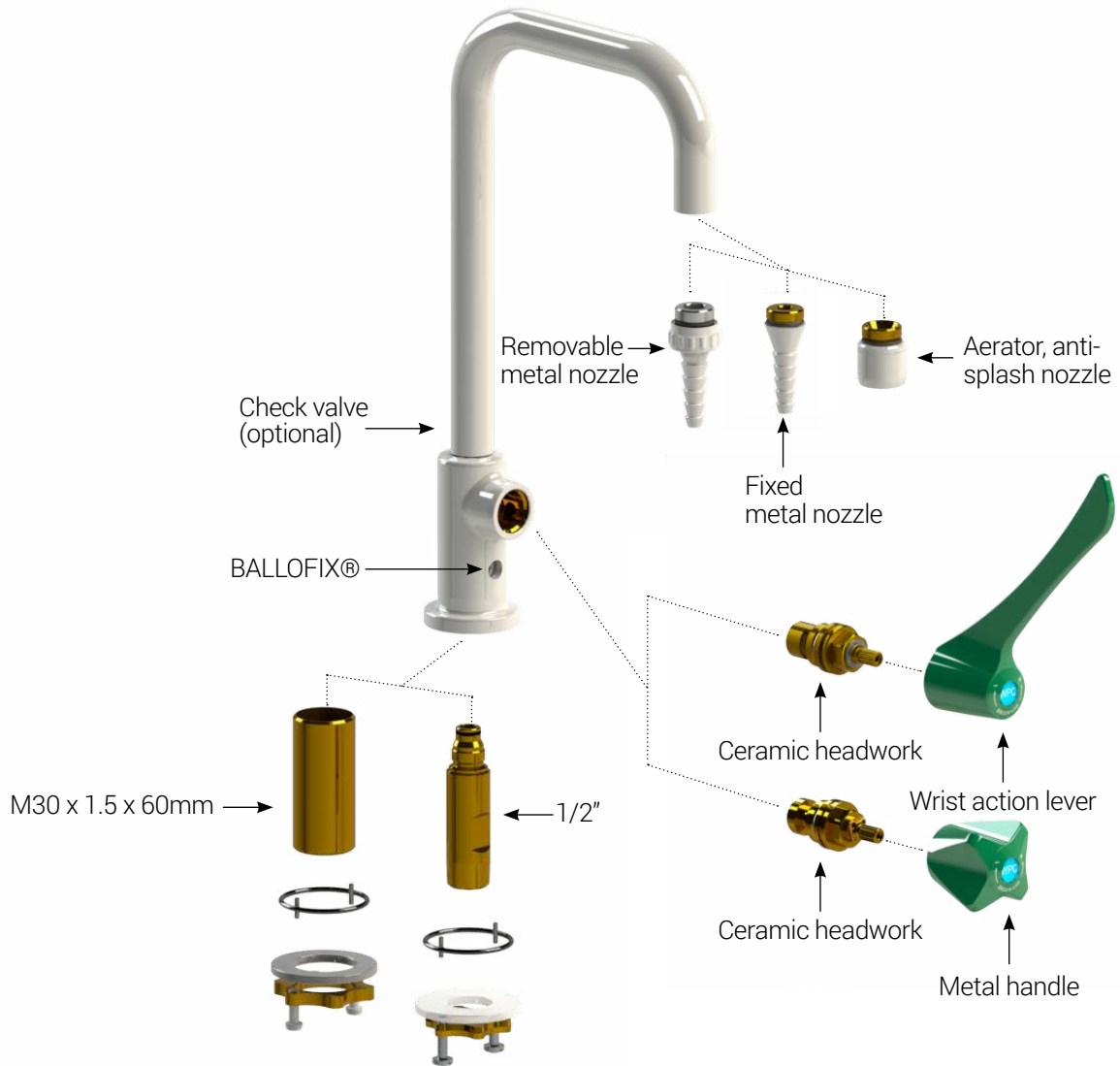

Optional hoses to add

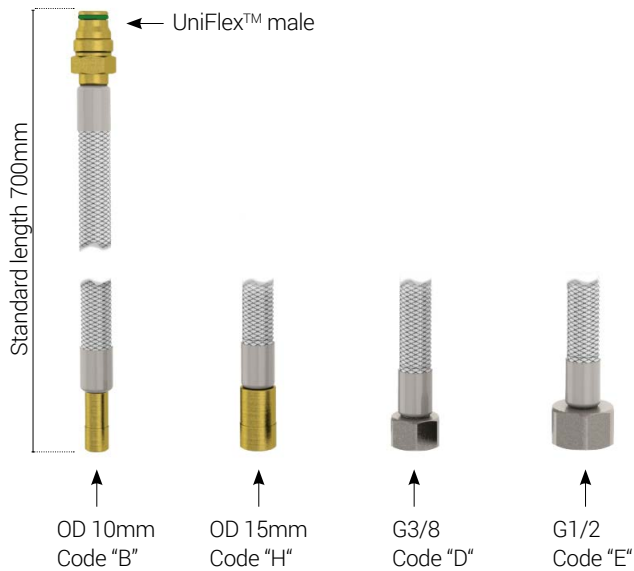

PRODUCT OVERVIEW
WATER MIXER

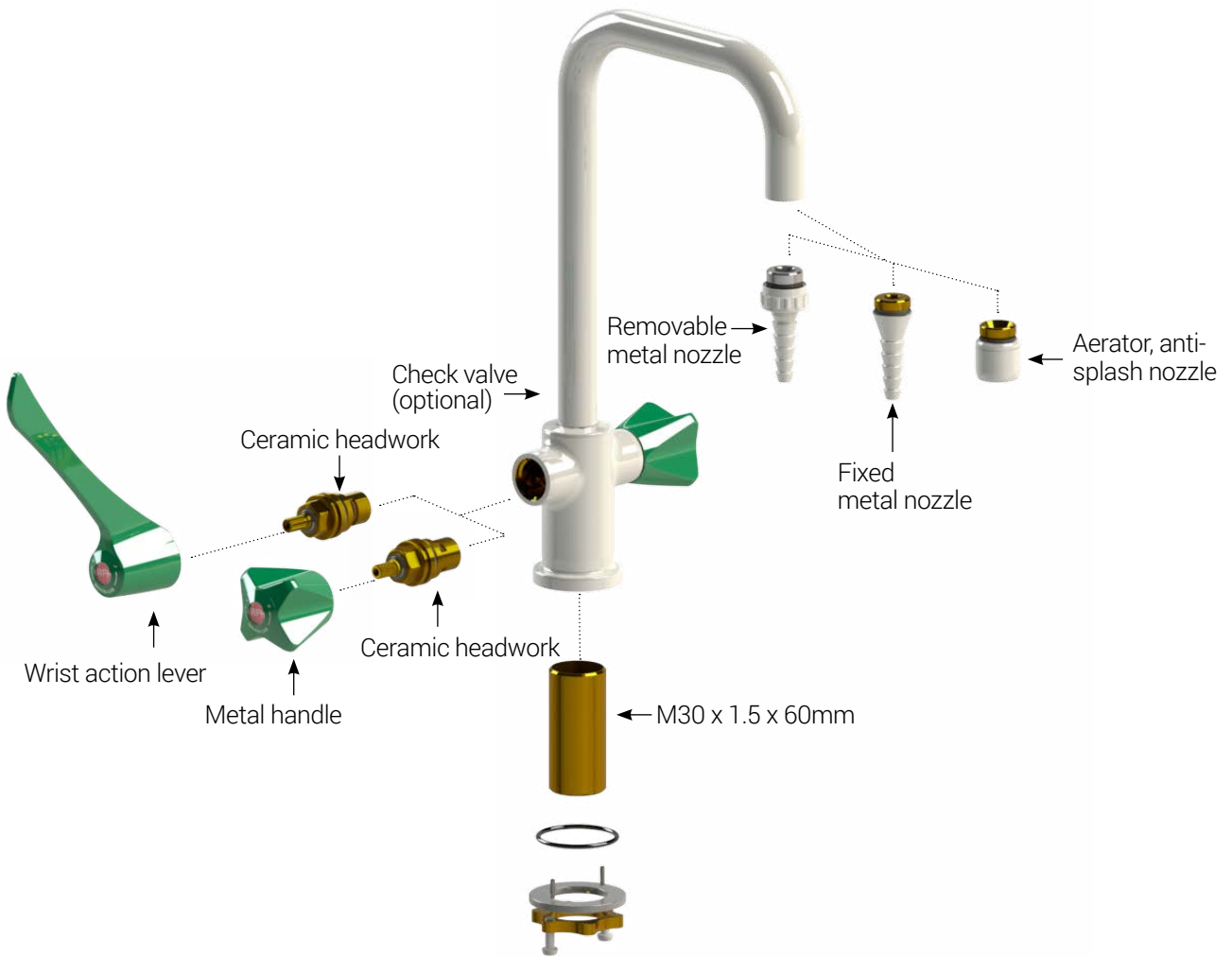

Optional hoses to add

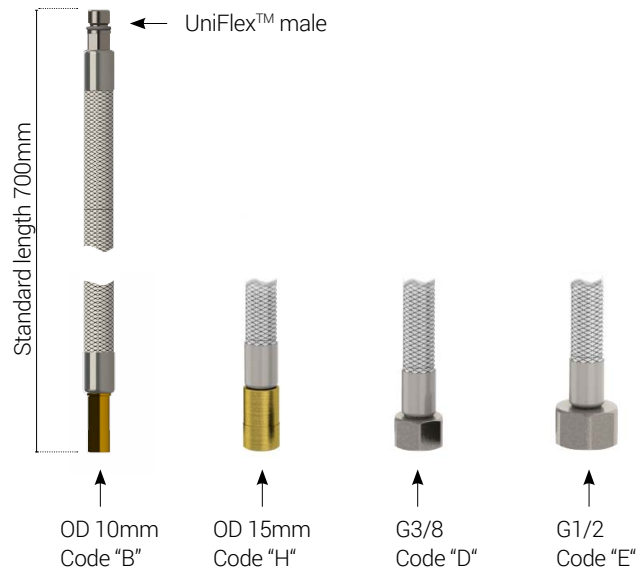

BENCH MOUNTED FITTING WITH SWIVEL SPOUT

SPECIFICATIONS

The fitting is delivered with an integrated BALLOFIX® ball valve.

Handle: Metal, BROEN-LAB POLYCOAT powder coated with media indication according to EN13792

Spout: Full swivel action

Hose nozzle: Removable metal

Headwork: Ceramic

Opening/closing function: 180° (wrist action lever: 90°)

Temperature range: 0-90°C

Max. working pressure: 10 bar / 147 psi

Test pressure: 1 x working pressure

Weight: 1.4 kg



MATERIALS WITH MEDIA CONTACT

Metals: Brass

Plastics: POM, PTFE

Sealing: EPDM

Lubricant: Silicone based

Ceramics: Al₂O₃ 96%

ORDERING INFORMATION

For standard configuration please refer to the item numbers below.

Other options:

- aerator
- flow restrictor (5 l/min)
- fixed hose nozzle
- integrated non-return valve
- fixed spout
- alternative hose inlet connection / without a hose
- other inlet options (type, length)
- national approvals
- WPH (Water Potable Hot)
- WNH (Water Non-Potable Hot)
- 110° limited swivel action

Configuration options

Choose outlet connection and number of valves:

	S = 150 mm	S = 200 mm	S = 250 mm	S = 300 mm
Metal handle	2534 001 10XX - YY	2534 002 10XX - YY	2534 017 10XX - YY	2534 016 10XX - YY
Wrist lever	2534 015 10XX - YY	2534 018 10XX - YY	2534 050 10XX - YY	2534 051 10XX - YY

Replace **XX** with one of these media types:



01 • Potable water, cold



02 • Potable water, hot



07 • Non-potable water, cold



08 • Non-potable water, hot

BENCH FITTING MOUNTED ON A COLUMN

SPECIFICATIONS

The fitting is delivered with an integrated BALLOFIX® ball valve.
 Handle: Metal, BROEN-LAB POLYCOAT powder coated with media indication according to EN13792
 Hose nozzle: Removable metal
 Headwork: Ceramic
 Opening/closing function: 180° (wrist action lever: 90°)
 Temperature range: 0-90°C
 Max. working pressure: 10 bar / 147 psi
 Test pressure: 1 x working pressure
 Weight: 1.5 kg

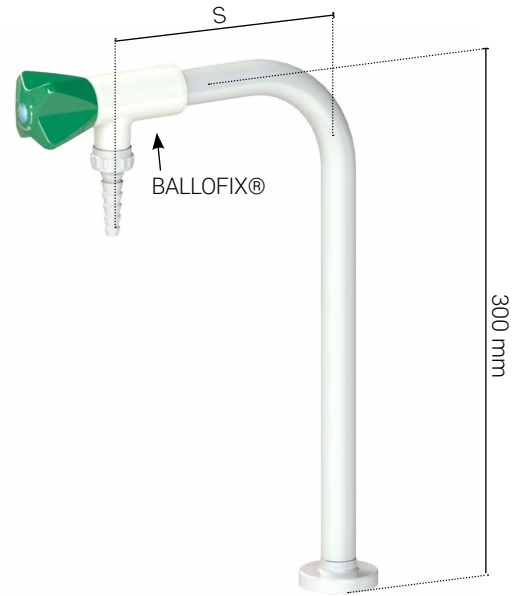

MATERIALS WITH MEDIA CONTACT

Metals: Brass
 Plastics: POM
 Sealing: EPDM
 Lubricant: Silicone based
 Ceramics: Al₂O₃ 96%

ORDERING INFORMATION

For standard configuration please refer to the item numbers below.

Other options:

- aerator
- flow restrictor (5 l/min)
- fixed hose nozzle
- integrated non-return valve
- alternative hose inlet connection / without a hose
- other inlet options (type, length)
- national approvals
- WPH (Water Potable Hot)
- WNH (Water Non-Potable Hot)

Configuration options

Choose handle and standout length

	S = 150 mm	S = 200 mm
Metal handle	2533 062 10XX - YY	2533 024 10XX - YY
Wrist lever	2533 067 10XX - YY	2533 025 10XX - YY

Replace **XX** with one of these media types:



01 • Potable water, cold



02 • Potable water, hot



07 • Non-potable water, cold



08 • Non-potable water, hot

BENCH MOUNTED TWO VALVE FITTING ON A U-SHAPED COLUMN

SPECIFICATIONS

The fitting is delivered with an integrated BALLOFIX® ball valve.

Handle: Metal, BROEN-LAB POLYCOAT powder coated with media indication according to EN13792

Hose nozzle: Removable metal

Headwork: Ceramic

Opening/closing function: 180° (wrist action lever: 90°)

Temperature range: 0-90°C

Max. working pressure: 10 bar / 147 psi

Test pressure: 1 x working pressure

Weight: 2.5 kg

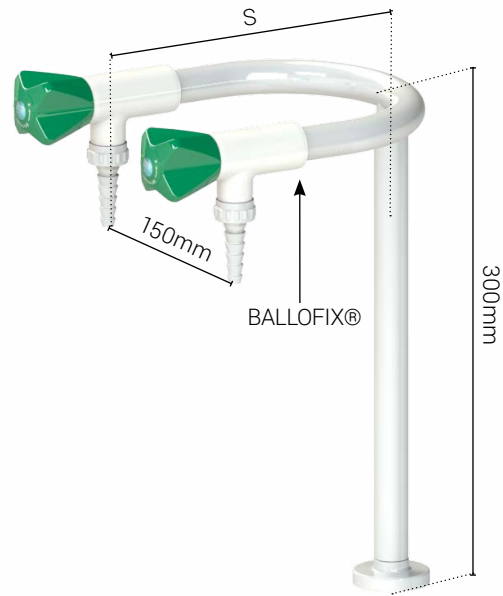

MATERIALS WITH MEDIA CONTACT

Metals: Brass

Plastics: POM

Sealing: EPDM

Lubricant: Silicone based

Ceramics: Al₂O₃ 96%

ORDERING INFORMATION

For standard configuration please refer to the item numbers below.

Other options:

- aerator
- flow restrictor (5 l/min)
- fixed hose nozzle
- integrated non-return valve
- alternative hose inlet connection / without a hose
- other inlet options (type, length)
- national approvals
- WPH (Water Potable Hot)
- WNH (Water Non-Potable Hot)

Configuration options

Choose handle and standout length

	S = 150 mm	S = 200 mm
Metal handle	2533 068 10XX - YY	2533 070 10XX - YY
Wrist lever	2533 069 10XX - YY	2533 071 10XX - YY

Replace **XX** with one of these media types:



01 • Potable water, cold



02 • Potable water, hot



07 • Non-potable water, cold



08 • Non-potable water, hot

BENCH MOUNTED TWO VALVE FITTING ON A T-SHAPED COLUMN

SPECIFICATIONS

The fitting is delivered with an integrated BALLOFIX® ball valve.

Handle: Metal, BROEN-LAB POLYCOAT powder coated with media indication according to EN13792

Hose nozzle: Removable metal

Headwork: Ceramic

Opening/closing function: 180° (wrist action lever: 90°)

Temperature range: 0-90°C

Max. working pressure: 10 bar / 147 psi

Test pressure: 1 x working pressure

Weight: 2.3 kg



MATERIALS WITH MEDIA CONTACT

Metals: Brass

Plastics: POM

Sealing: EPDM

Lubricant: Silicone based

Ceramics: Al₂O₃ 96%

ORDERING INFORMATION

For standard configuration please refer to the item numbers below.

Other options:

- aerator
- flow restrictor (5 l/min)
- fixed hose nozzle
- integrated non-return valve
- alternative hose inlet connection / without a hose
- other inlet options (type, length)
- national approvals
- WPH (Water Potable Hot)
- WNH (Water Non-Potable Hot)

Configuration options

Choose handle and standout length

	S = 300 mm	S = 400 mm
Metal handle	2533 072 10XX - YY	2533 074 10XX - YY
Wrist lever	2533 073 10XX - YY	2533 075 10XX - YY

Replace **XX** with one of these media types:



01 • Potable water, cold



02 • Potable water, hot



07 • Non-potable water, cold



08 • Non-potable water, hot

BENCH MOUNTED FITTING ON A COLUMN WITH SWIVEL SPOUT

SPECIFICATIONS

The fitting is delivered with an integrated BALLOFIX® ball valve.

Handle: Metal, BROEN-LAB POLYCOAT powder coated with media indication according to EN13792

Spout: Full swivel action

Hose nozzle: Removable metal

Headwork: Ceramic

Opening/closing function: 180° (wrist action lever: 90°)

Temperature range: 0-90°C

Max. working pressure: 10 bar / 147 psi

Test pressure: 1 x working pressure

Weight: 2 kg

MATERIALS WITH MEDIA CONTACT

Metals: Brass

Plastics: POM, PTFE

Sealing: EPDM

Lubricant: Silicone based

Ceramics: Al₂O₃ 96%

ORDERING INFORMATION

For standard configuration please refer to the item numbers below.

Other options:

- aerator
- flow restrictor (5 l/min)
- fixed hose nozzle
- wrist action lever
- integrated non-return valve
- other standouts (S):
- alternative hose inlet connection / without a hose
- other inlet options (type, length)
- national approvals
- WPH (Water Potable Hot)
- WNH (Water Non-Potable Hot)



Configuration options

Choose version and standout length

	S = 150 mm	S = 200 mm
U-shape	2533 076 10XX - YY	2533 077 10XX - YY
S-shape	2533 127 10XX - YY	2533 140 10XX - YY

Replace **XX** with one of these media types:



01 • Potable water, cold



02 • Potable water, hot



07 • Non-potable water, cold



08 • Non-potable water, hot

BENCH MOUNTED THREE WAY VALVE FITTING

SPECIFICATIONS

The fitting is delivered with an integrated BALLOFIX® ball valve.
 Handle: Metal, BROEN-LAB POLYCOAT powder coated with media indication according to EN13792
 Spout: Full swivel action
 Hose nozzle: Removable metal
 Headwork: Ceramic
 Opening/closing function: 180° (wrist action lever: 90°)
 Temperature range: 0-90°C
 Max. working pressure: 10 bar / 147 psi
 Test pressure: 1 x working pressure
 Weight: 3 kg

MATERIALS WITH MEDIA CONTACT

Metals: Brass
 Plastics: POM, PTFE
 Sealing: EPDM
 Lubricant: Silicone based
 Ceramics: Al₂O₃ 96%
 Solder: DIN L-Ag55:Sn

ORDERING INFORMATION

For standard configuration please refer to the item numbers below.

Other options:

- aerator
- flow restrictor (5 l/min)
- fixed hose nozzle
- integrated non-return valve
- alternative hose inlet connection / without a hose
- other inlet options (type, length)
- national approvals
- WPH (Water Potable Hot)
- WNH (Water Non-Potable Hot)

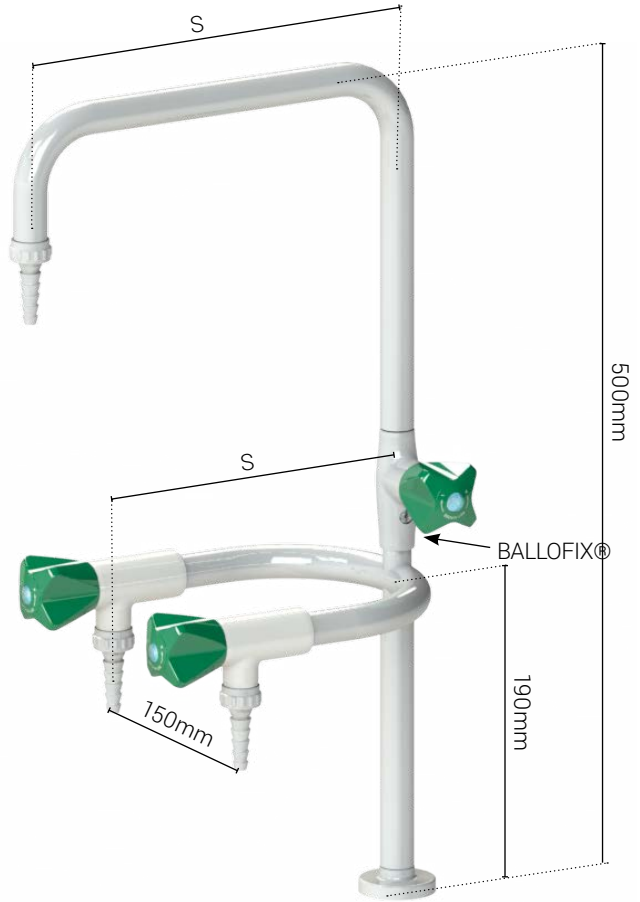

Configuration options

Choose handle

	S = 150 mm
Metal handle	2533 078 10XX - YY
Wrist lever	2533 079 10XX - YY

Replace **XX** with one of these media types:



01 • Potable water, cold



02 • Potable water, hot



07 • Non-potable water, cold



08 • Non-potable water, hot

BENCH MOUNTED HANDS-FREE SENSORTAP

SPECIFICATIONS

Spout: 110° swivel action
 Servo Controlled Bi-stable Cartridge valve
 Hose nozzle: Aerator
 Temperatur range: 5-65° (41°F - 149°F)
 Max. working pressure: 10 bar/145 psi
 Enforced flush 72 hours after last use
 Weight: 1.6 kg



MATERIALS WITH MEDIA CONTACT

Metals: Brass
 Plastics: PPSU, SS, PA, SPX (Hose)
 Sealing: Rubber, EPDM
 Lubricant: Silicone based

ORDERING INFORMATION

For standard configuration please refer to the item numbers below.



Other options:

- [See seperate catalogue 94G0246](#)

Configuration options

Choose electrical connection and version



	With fixed temperature	With temperature adjuster	With thermostatic mixing valve
Adaptor: 100-240 V AC 50/60 Hz 	2601 008 1035 - YY	2601 008 1035- YY * + 2602 002 1035E	2601 008 1035- YY * + 2603 011 1035E
Battery: 6 V Lithium 	2601 017 1035 - YY	2601 017 1035- YY * + 2602 002 1035E	2601 017 1035- YY * + 2603 011 1035E

WALL MOUNTED FITTING 90° VALVE

SPECIFICATIONS

The fitting is delivered with an integrated BALLOFIX® ball valve.

Handle: Metal, BROEN-LAB POLYCOAT powder coated with media indication according to EN13792

Hose nozzle: Removable metal

Headwork: Ceramic

Opening/closing function: 180° (wrist action lever: 90°)

Temperature range: 0-90°C

Max. working pressure: 10 bar / 147 psi

Test pressure: 1 x working pressure

Weight: 2.3 kg

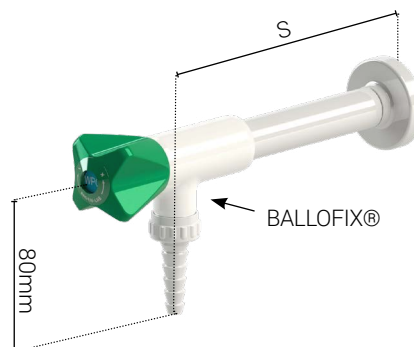

MATERIALS WITH MEDIA CONTACT

Metals: Brass

Plastics: POM

Sealing: EPDM

Lubricant: Silicone based

Ceramics: Al₂O₃ 96%

ORDERING INFORMATION

For standard configuration please refer to the item numbers below.

Other options:

- aerator
- flow restrictor (5 l/min)
- fixed hose nozzle
- integrated non-return valve
- angle valve with 45° hose nozzle
- alternative hose inlet connection / without a hose
- other inlet options (type, length)
- national approvals
- WPH (Water Potable Hot)
- WNH (Water Non-Potable Hot)

Configuration options

Choose handle and standout length

	S = 75 mm	S = 150 mm	S = 200 mm
Metal handle	2530 335 10XX - YY	2533 080 10XX - YY	2533 082 10XX - YY
Wrist lever	2530 337 10XX - YY	2533 081 10XX - YY	2533 083 10XX - YY

Replace **XX** with one of these media types:



01 • Potable water, cold



02 • Potable water, hot



07 • Non-potable water, cold



08 • Non-potable water, hot

WALL MOUNTED FITTING STRAIGHT VALVE

SPECIFICATIONS

The fitting is delivered with an integrated BALLOFIX® ball valve.

Handle: Metal, BROEN-LAB POLYCOAT powder coated with media indication according to EN13792

Hose nozzle: Removable metal

Headwork: Ceramic

Opening/closing function: 180°

Temperature range: 0-90°C

Max. working pressure: 10 bar / 147 psi

Test pressure: 1 x working pressure

Weight: 2.5 kg

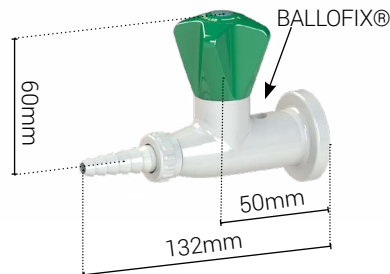

MATERIALS WITH MEDIA CONTACT

Metals: Brass

Plastics: POM

Sealing: EPDM

Lubricant: Silicone based

Ceramics: Al₂O₃ 96%

ORDERING INFORMATION

For standard configuration please refer to the item numbers below.

Other options:

- aerator
- flow restrictor (5 l/min)
- fixed hose nozzle
- alternative hose inlet connection / without a hose
- other inlet options (type, length)
- national approvals

Configuration options

Choose handle and version

	Without check valve	With check valve
Metal handle	2532 160 10XX - YY	2532 162 10XX - YY
Wrist lever	2532 161 10XX - YY	2532 163 10XX - YY

Replace **XX** with one of these media types:



01 • Potable water, cold



02 • Potable water, hot



07 • Non-potable water, cold



08 • Non-potable water, hot

WALL MOUNTED FITTING WITH SWIVEL U-SPOUT

SPECIFICATIONS

The fitting is delivered with an integrated BALLOFIX® ball valve.

Handle: Metal, BROEN-LAB POLYCOAT powder coated with media indication according to EN13792

Hose nozzle: Removable metal

Headwork: Ceramic

Opening/closing function: 180°

Temperature range: 0-90°C

Max. working pressure: 10 bar / 147 psi

Test pressure: 1 x working pressure

Weight: 2.5 kg

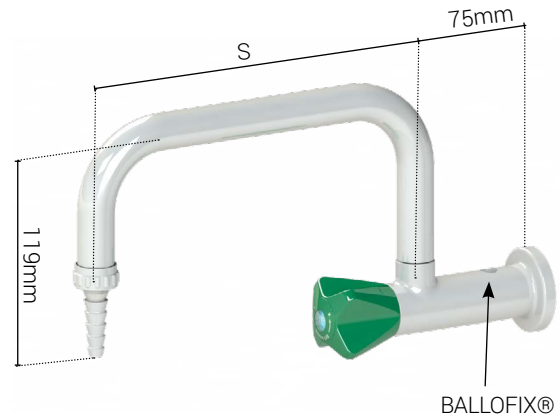

MATERIALS WITH MEDIA CONTACT

Metals: Brass

Plastics: POM

Sealing: EPDM

Lubricant: Silicone based

Ceramics: Al₂O₃ 96%

ORDERING INFORMATION

For standard configuration please refer to the item numbers below.

Other options:

- aerator
- flow restrictor (5 l/min)
- integrated check valve to prevent backflow
- fixed hose nozzle
- alternative hose inlet connection / without a hose
- other inlet options (type, length)
- national approvals
- WPH (Water Potable Hot)
- WNH (Water Non-Potable Hot)

Configuration options

Choose handle and stand out lenght

	S = 150 mm	S = 200 mm	S = 250 mm	S = 300 mm
Metal handle	2530 365 10XX - YY	2530 366 10XX - YY	2530 367 10XX - YY	2530 368 10XX - YY
Wrist lever	2530 369 10XX - YY	2530 370 10XX - YY	2530 371 10XX - YY	2530 372 10XX - YY

Replace **XX** with one of these media types:



01 • Potable water, cold



02 • Potable water, hot



07 • Non-potable water, cold



08 • Non-potable water, hot

WALL MOUNTED FITTING WITH SWIVEL S-SPOUT

SPECIFICATIONS

The fitting is delivered with an integrated BALLOFIX® ball valve.

Handle: Metal, BROEN-LAB POLYCOAT powder coated with media indication according to EN13792

Hose nozzle: Removable metal

Headwork: Ceramic

Opening/closing function: 180°

Temperature range: 0-90°C

Max. working pressure: 10 bar / 147 psi

Test pressure: 1 x working pressure

Weight: 2.5 kg

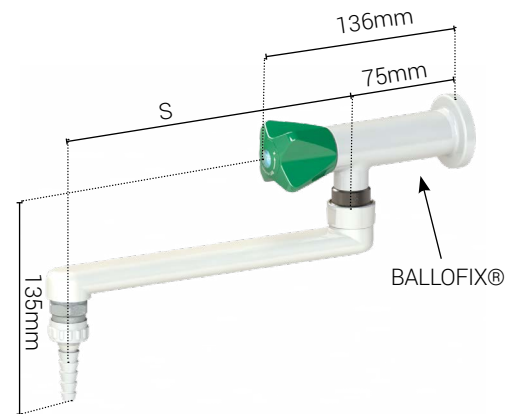

MATERIALS WITH MEDIA CONTACT

Metals: Brass

Plastics: POM

Sealing: EPDM

Lubricant: Silicone based

Ceramics: Al₂O₃ 96%

ORDERING INFORMATION

For standard configuration please refer to the item numbers below.

Other options:

- aerator
- flow restrictor (5 l/min)
- integrated check valve to prevent backflow
- fixed hose nozzle
- alternative hose inlet connection / without a hose
- other inlet options (type, length)
- national approvals
- WPH (Water Potable Hot)
- WNH (Water Non-Potable Hot)

Configuration options

Choose handle and stand out lenght

	S = 150 mm	S = 200 mm	S = 250 mm	S = 250 mm
Metal handle	2530 406 10XX - YY	2530 407 10XX - YY	2530 408 10XX - YY	2530 409 10XX - YY
Wrist lever	2530 410 10XX - YY	2530 411 10XX - YY	2530 412 10XX - YY	2530 413 10XX - YY

Replace **XX** with one of these media types:



01 • Potable water, cold



02 • Potable water, hot



07 • Non-potable water, cold



08 • Non-potable water, hot

WALL MOUNTED 90° FITTING WITH REAR WALL CONNECTION (RWC)

SPECIFICATIONS

The fitting is delivered with an integrated BALLOFIX® ball valve.
 Handle: Metal, BROEN-LAB POLYCOAT powder coated with media indication according to EN13792
 Hose nozzle: Removable metal
 Headwork: Ceramic
 Opening/closing function: 180° (wrist action lever: 90°)
 Temperature range: 0-90°C
 Max. working pressure: 10 bar / 147 psi
 Test pressure: 1 x working pressure
 Weight: 2.3 kg

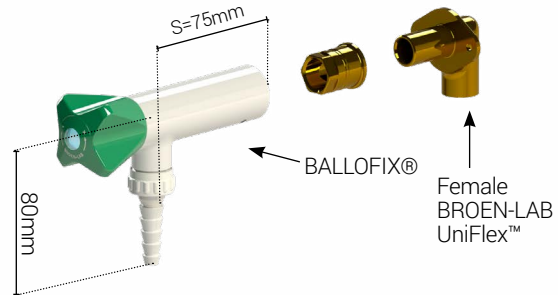

MATERIALS WITH MEDIA CONTACT

Metals: Brass
 Plastics: POM
 Sealing: EPDM
 Lubricant: Silicone based
 Ceramics: Al₂O₃ 96%

ORDERING INFORMATION

For standard configuration please refer to the item numbers below.

Other options:

- aerator
- flow restrictor (5 l/min)
- fixed hose nozzle
- integrated non-return valve
- angle valve with 45° hose nozzle
- other installation options:
 - flange
 - straight rear wall connection
 - wall thickness 20-40mm
 - additional support in case of a thin panel

Configuration options

Choose handle and version

	Without check valve	With check valve
Metal handle	2530 421 10XX -40	2530 467 10XX -40
Wrist lever	2530 422 10XX -40	2530 468 10XX -40

Replace **XX** with one of these media types:



01 • Potable water, cold



02 • Potable water, hot



07 • Non-potable water, cold



08 • Non-potable water, hot

WALL MOUNTED STRAIGHT FITTING WITH REAR WALL CONNECTION (RWC)

Specifications

The fitting is delivered with an integrated BALLOFIX® ball valve.

Handle: Metal, BROEN-LAB POLYCOAT powder coated with media indication according to EN13792

Hose nozzle: Removable metal

Headwork: Ceramic

Opening/closing function: 180° (wrist action lever: 90°)

Temperature range: 0-90°C

Max. working pressure: 10 bar / 147 psi

Test pressure: 1 x working pressure

Weight: 2.3 kg

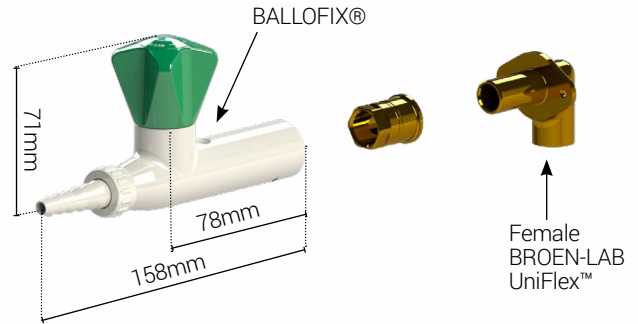

MATERIALS WITH MEDIA CONTACT

Metals: Brass

Plastics: POM

Sealing: EPDM

Lubricant: Silicone based

Ceramics: Al₂O₃ 96%

ORDERING INFORMATION

For standard configuration please refer to the item numbers below.

Other options:

- aerator
- flow restrictor (5 l/min)
- fixed hose nozzle
- integrated non-return valve
- angle valve with 45° hose nozzle
- flange
- straight rear wall connection
- wall thickness 20-40mm
- additional support in case of a thin panel

Configuration options

Choose handle and version

	Without check valve	With check valve
Metal handle	2532 209 10XX -40	2532 210 10XX -40
Wrist lever	2532 211 10XX -40	2532 212 10XX -40

Replace **XX** with one of these media types:



01 • Potable water, cold



02 • Potable water, hot



07 • Non-potable water, cold



08 • Non-potable water, hot

WALL MOUNTED FITTING WITH SWIVEL U-SPOUT AND REAR WALL CONNECTION (RWC)

SPECIFICATIONS

The fitting is delivered with an integrated BALLOFIX® ball valve.

Handle: Metal, BROEN-LAB POLYCOAT powder coated with media indication according to EN13792

Hose nozzle: Removable metal

Headwork: Ceramic

Opening/closing function: 180° (wrist action lever: 90°)

Temperature range: 0-90°C

Max. working pressure: 10 bar / 147 psi

Test pressure: 1 x working pressure

Weight: 2.3 kg

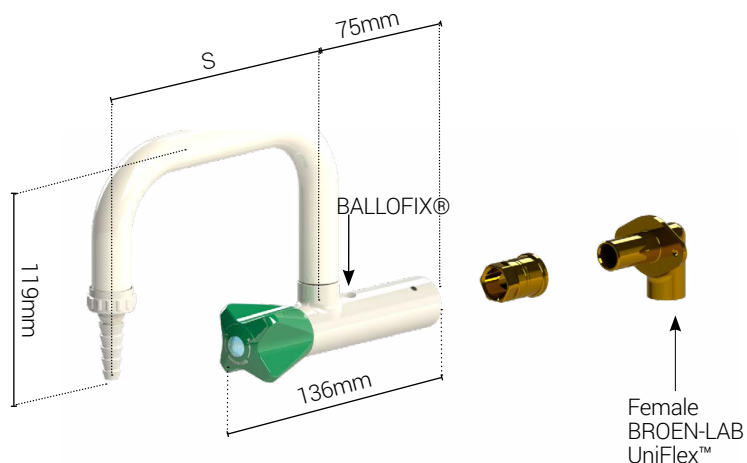

MATERIALS WITH MEDIA CONTACT

Metals: Brass

Plastics: POM

Sealing: EPDM

Lubricant: Silicone based

Ceramics: Al₂O₃ 96%

ORDERING INFORMATION

For standard configuration please refer to the item numbers below.

Other options:

- aerator
- flow restrictor (5 l/min)
- fixed hose nozzle
- integrated non-return valve
- S-spout
- national approvals

Configuration options

Choose handle and stand out length

	S = 150 mm	S = 200 mm	S = 250 mm	S = 250 mm
Metal handle	2530 469 10XX -40	2530 470 10XX -40	2530 471 10XX -40	2530 472 10XX -40
Wrist lever	2530 473 10XX -40	2530 474 10XX -40	2530 475 10XX -40	2530 476 10XX -40

Replace **XX** with one of these media types:



01 • Potable water, cold



02 • Potable water, hot



07 • Non-potable water, cold



08 • Non-potable water, hot

WALL MOUNTED FITTINGS WITH 90° VALVES FOR EXPOSED PIPING OR BUILT-IN INSTALLATION

SPECIFICATIONS

The fitting is delivered with an integrated BALLOFIX® ball valve.

Handle: Metal, BROEN-LAB POLYCOAT powder coated with media indication according to EN13792

Hose nozzle: Removable metal

Headwork: Ceramic

Opening/closing function: 180° (wrist action lever: 90°)

Temperature range: 0-90°C

Max. working pressure: 10 bar / 147 psi

Test pressure: 1 x working pressure

Weight: 2.3 kg

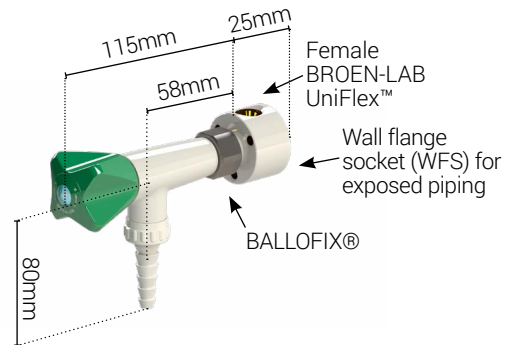

MATERIALS WITH MEDIA CONTACT

Metals: Brass

Plastics: POM

Sealing: EPDM

Lubricant: Silicone based

Ceramics: Al₂O₃ 96%

ORDERING INFORMATION

For standard configuration please refer to the item numbers below.

Other options:

- aerator
- flow restrictor (5 l/min)
- fixed hose nozzle
- integrated non-return valve

Valve with a wall flange socket for built-in installation

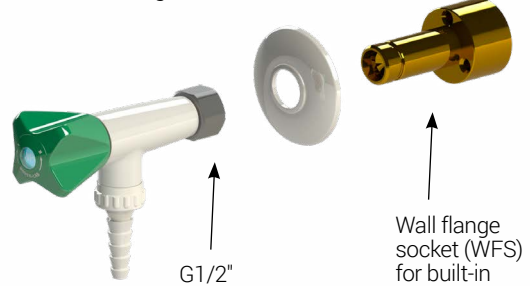

Configuration options

Choose handle and connection

	without WFS	with WFS for exposed piping	with WFS for built-in-installation
Metal handle	2530 172 10XX	2530 280 10XX	2530 255 10XX
Wrist lever	2530 383 10XX	2530 285 10XX	2530 384 10XX

Replace **XX** with one of these media types:



01 • Potable water, cold



02 • Potable water, hot



07 • Non-potable water, cold



08 • Non-potable water, hot

WALL MOUNTED FITTINGS WITH STRAIGHT VALVES FOR EXPOSED PIPING OR BUILT-IN INSTALLATION

SPECIFICATIONS

The fitting is delivered with an integrated BALLOFIX® ball valve.
 Handle: Metal, BROEN-LAB POLYCOAT powder coated with media indication according to EN13792
 Hose nozzle: Removable metal
 Headwork: Ceramic
 Opening/closing function: 180° (wrist action lever: 90°)
 Temperature range: 0-90°C
 Max. working pressure: 10 bar / 147 psi
 Test pressure: 1 x working pressure
 Weight: 2.3 kg

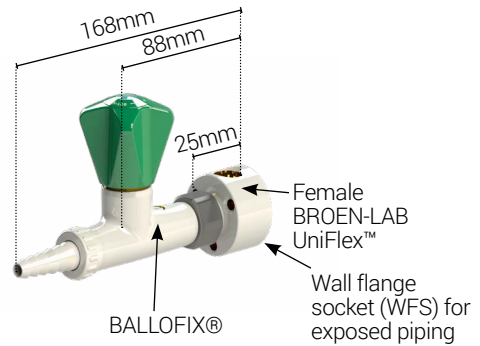

MATERIALS WITH MEDIA CONTACT

Metals: Brass
 Plastics: POM
 Sealing: EPDM
 Lubricant: Silicone based
 Ceramics: Al₂O₃ 96%

ORDERING INFORMATION

For standard configuration please refer to the item numbers below.

Other options:

- aerator
- flow restrictor (5 l/min)
- fixed hose nozzle
- integrated non-return valve

Valve with a wall flange socket for built-in installation



Configuration options

Choose handle and connection

	without WFS	with WFS for exposed piping	with WFS for built-in installation
Metal handle	2532 155 10XX	2532 179 10XX	2532 111 10XX
Wrist lever	2532 215 10XX	2532 176 10XX	2532 216 10XX

Replace **XX** with one of these media types:



01 • Potable water, cold



02 • Potable water, hot



07 • Non-potable water, cold



08 • Non-potable water, hot

SUSPENDED FITTING WITH TWO 90° VALVE

SPECIFICATIONS

The fitting is delivered with an integrated BALLOFIX® ball valve.

Handle: Metal, BROEN-LAB POLYCOAT powder coated with media indication according to EN13792

Hose nozzle: Removable metal

Headwork: Ceramic

Opening/closing function: 180°

Temperature range: 0-90°C

Max. working pressure: 10 bar / 147 psi

Test pressure: 1 x working pressure

Weight: 2.5 kg

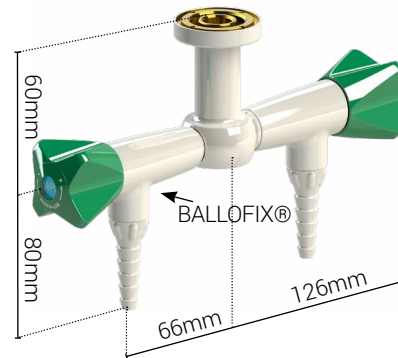

MATERIALS WITH MEDIA CONTACT

Metals: Brass

Plastics: POM

Sealing: EPDM

Lubricant: Silicone based

Ceramics: Al₂O₃ 96%

ORDERING INFORMATION

For standard configuration please refer to the item numbers below.

Other options:

- aerator
- fixed hose nozzle
- flow restrictor (5 l/min)
- wrist action levers
- models with single valve, 2 valves 90° and 4 valves
- alternative hose inlet connection / without a hose
- other inlet options (type, length)
- national approvals

Configuration options

Choose handle

	2-valves 180°
Metal handle	2530 047 10XX - YY
Wrist lever	2530 373 10XX - YY

Replace **XX** with one of these media types:



01 • Potable water, cold



02 • Potable water, hot



07 • Non-potable water, cold



08 • Non-potable water, hot

BENCH MOUNTED TWO HANDLE ONE HOLE MIXER WITH SWIVEL SPOUT

SPECIFICATIONS

Handle: Metal, BROEN-LAB POLYCOAT powder coated with media indication according to EN13792
 Spout: Full swivel action
 Hose nozzle: Removable metal
 Headwork: Ceramic
 Opening/closing function: 180° (wrist action lever: 90°)
 Temperature range: 0-90°C
 Max. working pressure: 10 bar / 147 psi
 Test pressure: 1 x working pressure
 Weight: 1.8 kg

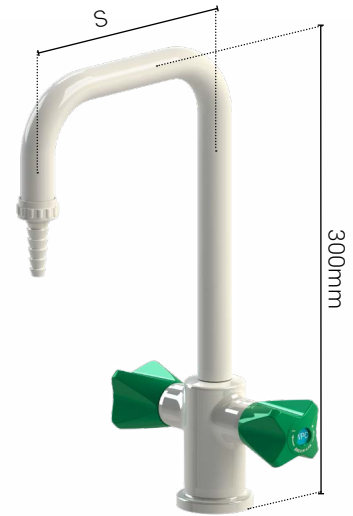

MATERIALS WITH MEDIA CONTACT

Metals: Brass
 Plastics: POM, PTFE
 Sealing: EPDM
 Lubricant: Silicone based
 Ceramics: Al₂O₃ 96%

ORDERING INFORMATION

For standard configuration please refer to the item numbers below.

Other options:

- aerator
- flow restrictor (5 l/min)
- fixed hose nozzle
- integrated non-return valve
- fixed spout
- alternative hose inlet connection / without a hose
- OD 10mm Cu pipes
- other inlet options
- national approvals
- 110° limited swivel action

Configuration options

Choose handle and stand out lenght

	S = 150 mm	S = 200 mm	S = 250 mm	S = 300 mm
Metal handle	2536 001 10XX - YY	2536 002 10XX - YY	2536 013 10XX - YY	2536 012 10XX - YY
Wrist lever	2536 028 10XX - YY	2536 014 10XX - YY	2536 037 10XX - YY	2536 040 10XX - YY

Replace **XX** with one of these media types:



39 • Water potable (WPC /WPH)



40 • Water non-potable (WNC /WNH)

BENCH MOUNTED ONE HANDLE ONE HOLE MIXER

SPECIFICATIONS

Handle: Metal, BROEN-LAB POLYCOAT powder coated
Spout: 110° limited swivel action
Hose nozzle: Removable plastic (aerator included)
Cartridge: Ceramic (temperature and flow regulation type)
Opening/closing function: 25°, mixing function: ±45°
Temperature range: 0°C - 65°C
Max. working pressure: 10 bar / 147 psi
Weight: 2.8 kg

MATERIALS WITH MEDIA CONTACT

Metals: Brass
Plastics: PP, POM, PTFE, SPX (hose)
Sealing: EPDM
Lubricant: Silicone based
Ceramics: Al₂O₃ 96%

ORDERING INFORMATION

For standard configuration please refer to the item numbers below.

Other options:

- no swivel action
- full swivel action



Configuration options

	S = 200 mm
	G35 031 8135

BENCH MOUNTED ONE HANDLE ONE HOLE BIOLAB MIXER

SPECIFICATIONS

Handle: Metal, BROEN-LAB POLYCOAT powder coated with media indication

Spout: 110° swivel action

Aerator

Ceramic cartridge

Opening/closing function: 22,5°, mix. function ±45°

Temperature range: 5°C-65°C

Max. working pressure: 10 bar / 147 psi

Weight: 1.7 kg



MATERIALS WITH MEDIA CONTACT

Metals: Brass

Sealing: Rubber, EPDM

Lubricant: Silicone based

Ceramics: Al₂O₃ 96%



ORDERING INFORMATION

For standard configuration please refer to the item numbers below.

Other options:

Configuration options

Choose handle

Handle body: BROEN-LAB colour 5168		2535 271 10XX - YY
Handle body: BROEN-LAB colour 2700		2535 272 10XX - YY

Replace **XX** with one of these media types:



35 • Water potable (WPC /WPH)



37 • Water non-potable (WNC /WNH)

BENCH MOUNTED ONE HANDLE ONE HOLE MIXER

SPECIFICATIONS

Handle: Metal, BROEN-LAB POLYCOAT powder coated
 Spout: Swivel action
 Hose nozzle: Aerator
 Cartridge: Ceramic (temperature and flow regulation type)
 Opening/closing function: 25°, mixing function: ±45°
 Temperature range: 0°C - 90°C
 Max. working pressure: 10 bar / 147 psi
 Test pressure: 1 x working pressure
 Weight: 2.4 kg



MATERIALS WITH MEDIA CONTACT

Metals: Brass
 Plastics: POM, PTFE
 Sealing: EPDM
 Lubricant: Silicone based
 Ceramics: Al₂O₃ 96%

ORDERING INFORMATION

For standard configuration please refer to the item numbers below.

Other options:

- integrated non-return valve
- removable and fixed hose nozzles
- flow restrictor (5 l/min)
- alternative hose inlet connections
- 10mm Cu pipes
- 110° limited swivel action

Configuration options

Choose standout length

	S = 150 mm	S = 200 mm	S = 250 mm	S = 300 mm
	2535 038 1035 - YY	2535 039 1035 - YY	2535 040 1035 - YY	2535 041 1035 - YY

BENCH MOUNTED ONE HANDLE ONE HOLE MIXER WITH HAND SHOWER

SPECIFICATIONS

Handle: Metal, BROEN-LAB POLYCOAT powder coated
 Spout: Swivel action
 Hose nozzle: Aerator
 Cartridge: Ceramic (temperature and flow regulation type)
 Opening/closing function: 25°, mixing function: ±45°
 Temperature range: 0°C - 90°C
 Max. working pressure: 10 bar / 147 psi
 Test pressure: 1 x working pressure
 Weight: 3.0 kg

MATERIALS WITH MEDIA CONTACT

Metals: Brass
 Plastics: POM, PTFE, SPX (hose), ABS
 Sealing: EPDM
 Lubricant: Silicone based
 Ceramics: Al₂O₃ 96%

ORDERING INFORMATION

For standard configuration please refer to the item numbers below.

Other options:

- integrated non-return valve
- removable and fixed hose nozzles
- flow restrictor (5 l/min)
- 110° limited swivel action

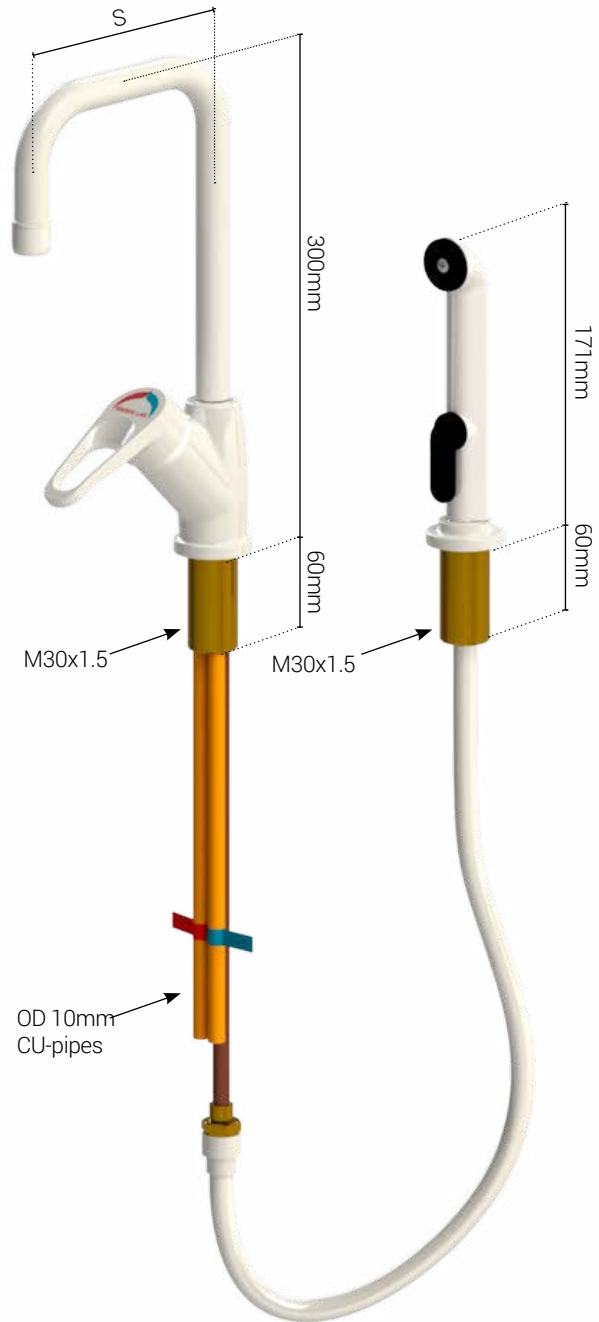

Configuration options

Choose standout length

	S = 150 mm	S = 200 mm	S = 250 mm	S = 300 mm
	2535 042 1035-52C	2535 043 1035-52C	2535 044 1035-52C	2535 045 1035-52C

BENCH MOUNTED TWO HANDLE TWO HOLE MIXER ON COLUMNS WITH SWIVEL SPOUT

SPECIFICATIONS

Handle: Metal, BROEN-LAB POLYCOAT powder coated with media indication according to EN13792

Spout: Full swivel action

Hose nozzle: Removable metal

Headwork: Ceramic

Opening/closing function: 180° (wrist action lever: 90°)

Temperature range: 0-90°C

Max. working pressure: 10 bar / 147 psi

Test pressure: 1 x working pressure

Weight: 1.8 kg



MATERIALS WITH MEDIA CONTACT

Metals: Brass

Plastics: POM, PTFE

Sealing: EPDM

Lubricant: Silicone based

Ceramics: Al₂O₃ 96%

ORDERING INFORMATION

For standard configuration please refer to the item numbers below.

Other options:

- aerator
- flow restrictor (5 l/min)
- integrated check valve
- S-spout
- other inlet lengths and options

For further information please contact your local BROEN-LAB representative.

Configuration options

Choose handle and standout length

	S = 150 mm	S = 200 mm	S = 250 mm	S = 300 mm
Metal handle	2536 120 10XX - YY	2536 121 10XX - YY	2536 122 10XX - YY	2536 123 10XX - YY
Wrist lever	2536 124 10XX - YY	2536 125 10XX - YY	2536 126 10XX - YY	2536 127 10XX - YY

Replace **XX** with one of these media types:



39 • Water potable (WPC /WPH)



40 • Water non-potable (WNC /WNH)

BENCH/WALL MOUNTED TWO HANDLE TWO HOLE MIXER WITH SWIVEL SPOUT

SPECIFICATIONS

The fitting is delivered with an integrated BALLOFIX® ball valve.
 Handle: Metal, BROEN-LAB POLYCOAT powder coated with media indication according to EN13792
 Spout: Full swivel action
 Hose nozzle: Removable metal
 Headwork: Ceramic
 Opening/closing function: 180° (wrist action lever: 90°)
 Temperature range: 0-90°C
 Max. working pressure: 10 bar / 147 psi
 Test pressure: 1 x working pressure
 Weight: 1.8 kg

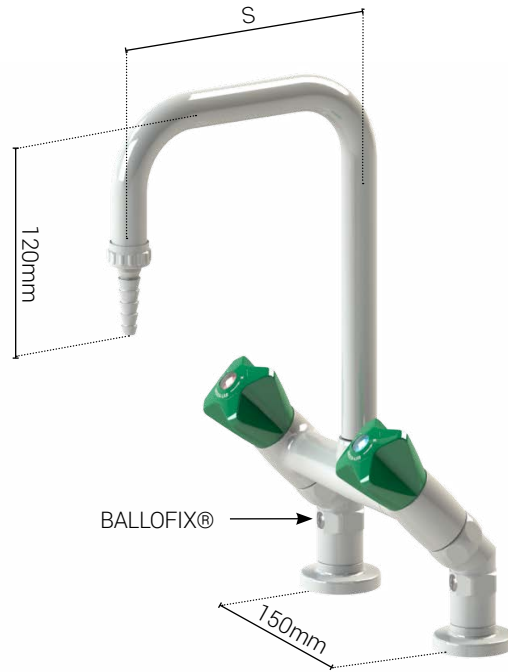

MATERIALS WITH MEDIA CONTACT

Metals: Brass
 Plastics: POM, PTFE
 Sealing: EPDM
 Lubricant: Silicone based
 Ceramics: Al₂O₃ 96%

ORDERING INFORMATION

For standard configuration please refer to the item numbers below.

- Other options:
- aerator
 - flow restrictor (5 l/min)
 - other standouts (250mm, 300mm)
 - S-spout
 - integrated check valve
 - other inlet lengths and options
 - 110° limited swivel action

For further information please contact your local BROEN LAB representative.

Configuration options

Choose handle and standout length

	S = 150 mm	S = 200 mm
Metal handle	2536 097 10XX - YY	2536 061 10XX - YY
Wrist lever	2536 098 10XX - YY	2536 078 10XX - YY

Replace **XX** with one of these media types:



39 • Water potable (WPC /WPH)



40 • Water non-potable (WNC /WNH)

WALL MOUNTED TWO HANDLE TWO HOLE MIXER WITH SWIVEL SPOUT

SPECIFICATIONS

Handle: Metal, BROEN-LAB POLYCOAT powder coated with media indication according to EN13792

Spout: Full swivel action

Hose nozzle: Removable metal

Headwork: Ceramic

Opening/closing function: 180° (wrist action lever: 90°)

Temperature range: 0-90°C

Max. working pressure: 10 bar / 147 psi

Test pressure: 1 x working pressure

Weight: 1.8 kg

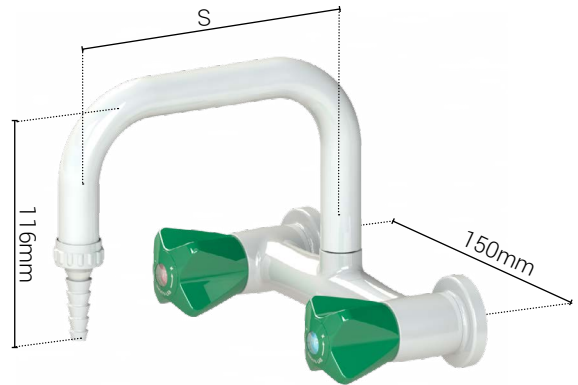

MATERIALS WITH MEDIA CONTACT

Metals: Brass

Plastics: POM, PTFE

Sealing: EPDM

Lubricant: Silicone based

Ceramics: Al₂O₃ 96%

ORDERING INFORMATION

For standard configuration please refer to the item numbers below.

Other options:

- aerator
- flow restrictor (5 l/min)
- integrated check valve
- S-spout
- other inlet lengths and options (RWC, eccentric, etc.)
- other options for hose inlet connections
- 110° limited swivel action

For further information please contact your local BROEN-LAB representative.

Configuration options

Choose handle and standout length

	S = 150 mm	S = 200 mm	S = 250 mm	S = 300 mm
Metal handle	2536 128 10XX - YY	2536 129 10XX - YY	2536 130 10XX - YY	2536 131 10XX - YY
Wrist lever	2536 132 10XX - YY	2536 133 10XX - YY	2536 134 10XX - YY	2536 135 10XX - YY

Replace **XX** with one of these media types:



39 • Water potable (WPC /WPH)



40 • Water non-potable (WNC /WNH)

WALL MOUNTED ONE HANDLE TWO HOLE MIXER WITH SWIVEL SPOUT

SPECIFICATIONS

Handle: Metal, BROEN-LAB POLYCOAT powder coated
 Spout: Swivel action
 Hose nozzle: Aerator
 Cartridge: Ceramic (temperature and flow regulation type)
 Opening/closing function: 25°, mixing function: ±45°
 Temperature range: 0°C - 90°C
 Max. working pressure: 10 bar / 147 psi
 Test pressure: 1 x working pressure
 Inlets: Eccentric couplings with male G1/2
 Weight: 1.5 kg

MATERIALS WITH MEDIA CONTACT

Metals: Brass
 Plastics: POM, PTFE
 Sealing: EPDM
 Lubricant: Silicone based
 Ceramics: Al₂O₃ 96%

ORDERING INFORMATION

For standard configuration please refer to the item numbers below.

Other options:

- removable hose nozzle
- bench mounted model
- different inlet connections
 (with BROEN-LAB UniFlex™ rear wall connection, lead-in. etc)

With long handle

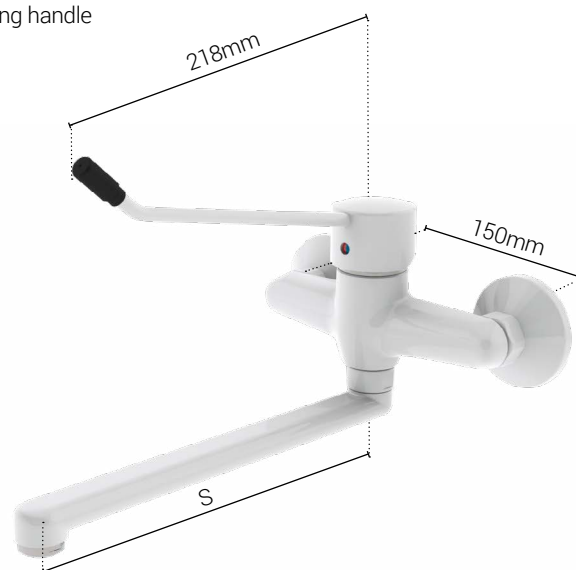

With short handle

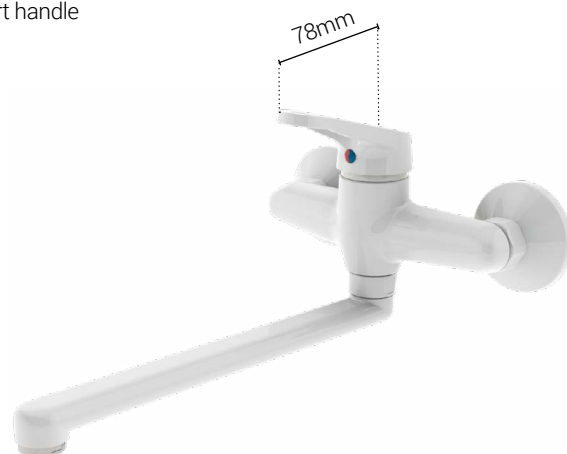

Configuration options

Choose handle and stand out lenght

	S = 200 mm	S = 250 mm	S = 300 mm
Long handle	2535 010 1035	2535 001 1035	2535 016 1035
Short handle	2535 007 1035	2535 004 1035	2535 013 1035

BROEN-LAB UNIFLEX™ HOSES FOR WATER

BROEN-LAB UniFlex™ flexible hoses



BROEN-LAB offers BROEN-LAB UniFlex™ hoses as an easy way to make the installation in the laboratory where safety and efficiency are required. BROEN-LAB UniFlex™ hoses are the ideal solution where there is a higher requirement for flexibility. Installation with flexible hoses saves you time and labor • in other words reduced installation costs.

A wide range of fittings and lengths available for BROEN-LAB UniFlex™ hoses enables customers to choose the perfect hose for their application.

BROEN-LAB UniFlex™ hoses for water are manufactured of soft cross-linked polyethylene (SPX), which is approved for use with drinking water and meets all hygienic requirements. From the outside the hose is secured by a Stainless Steel braiding that ensures long service life and durability.

BROEN-LAB UniFlex™ connection fittings and adaptors for CU, Stainless Steel and PEX pipes



The total design of the system must be taken into consideration when selecting the type of BROEN-LAB UniFlex™ flexible hose or pipe for specific media. Only then products will provide safe, trouble-free operation.











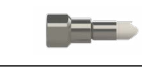

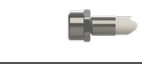

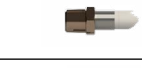
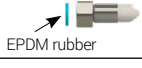

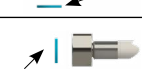
Please always check local requirements/regulations regarding installation and maintenance of hoses/flexible pipes!

A very high quality of materials applied for production of hoses and Stainless Steel flexible pipes, which are supplied by BROEN-LAB, and a long-time experience in making installations worldwide, combined with optimal installation conditions, may assure a lifetime for a hose to be more than 10 years. Expected lifetime can only be achieved under normal use and proper installation methods, which are described in technical specifications, i.e. max. working pressure, max. temperature, physical installation methods and other. Any nonconformity to specifications decreases the lifetime of a hose/flexible pipe.

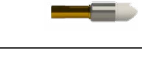

Hose	SPX
Factors*	93V
Inner hose material with media contact	SPX
Outer hose material / braiding	Stainless Steel AISI 304
Sealing material	EPDM
Inside diameter	8.2 mm
Outside diameter	12 mm
Max. working pressure	10 bar
Max. working temperature	90°C
Min. bending radius (inner)	40 mm
Leakage rate	-
UV resistance	++
Range of connections	+++

93V - BROEN-LAB UNIFLEX™ SPX HOSES FOR WATER

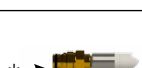
INLET CONNECTIONS 93 V XX XX XXXX

61	3/8" NPT swivel connection	
32	Male G3/8" fixed connection	
31	Male G1/2" fixed connection	
33	Male G3/4" fixed connection	
34	3/8" NPT fixed connection	
35	3/8" NPT swivel connection	
41	Female G3/8" union nut connection	
46	90° Female G3/8" union nut connection	
40	Female G1/2" union nut connection	
45	90° Female G1/2" union nut connection	
42	Female G3/4" union nut connection	
09	OD3/8" connection compression fitting	
10	OD10mm connection for compression fittings	
12	OD12mm connection for compression fittings	
13	OD1/2" connection for compression fittings	
15	OD15mm connection for compression fittings	
65	OD15mm connection for press fittings	
20	Straight BROEN-LAB UniFlex™ connection with EPDM O-ring	
25	45° BROEN-LAB UniFlex™ connection with EPDM O-ring	
30	90° BROEN-LAB UniFlex™ connection with EPDM O-ring	

OUTLET CONNECTIONS 93 V XX XX XXXX

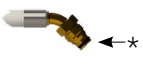
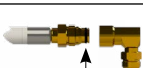
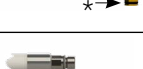
20	Straight BROEN-LAB UniFlex™ connection with EPDM O-ring	
25	45° BROEN-LAB UniFlex™ connection with EPDM O-ring	
30	90° BROEN-LAB UniFlex™ connection with EPDM O-ring	
51	M10x1mm short connection with EPDM O-ring	
Please note: M10 connections can only be used for mixers and multimedia fittings		
52	M10x1mm long connection with EPDM O-ring	
Please note: M10 connections can only be used for mixers and multimedia fittings		

*All O-rings are lubricated with silicone based lubricant

SPECIFICATIONS

Inner hose material: SPX (soft PEX)
 Braiding: Stainless Steel with one green stripe
 Materials with media contact: SPX, brass, EPDM with silicone based lubricant
 Sealing: EPDM, Aramid fiber/NBR
 Inside diameter: 8.2 mm
 Outside diameter: 12 mm
 Max. working pressure: 10 bar
 Max. working temperature: 90°C
 Bending radius (inner): ≥ 40 mm
 Min. length with connections: 160 mm

LENGTH 93 V XX XX XXXX

SPX hose with braiding in Stainless Steel



Marking for water with Part no. and Media indication

HOSE LENGTHS

Definition of length (L)

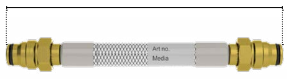

Definition of length (L)

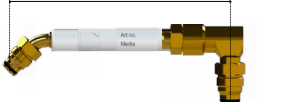

If 45° and 90° elbows occur on the same hose, it will as default be mounted in U-form

**Standard lengths of hoses (L):

- 0500** = 500 mm
- 0700** = 700 mm
- 1000** = 1000 mm
- 1200** = 1200 mm
- 1500** = 1500 mm
- 2000** = 2000 mm
- 2500** = 2500 mm
- 3000** = 3000 mm

Length tolerance of hoses:
 L = ≤400 mm (-0, +10 mm)
 L = 401 mm to 1000 mm (-0, +20 mm)
 L = >1000 mm (-0, +30 mm)

** Other lengths are available on request

EXAMPLE OF HOSE CONFIGURATION

1200 mm hose with OD 12 mm inlet connection and straight UniFlex™ outlet connection



93V12201200

HEADWORK - METAL HANDLE

Specifications

BROEN-LAB UniFlex™ water fittings with metal handles are delivered with ceramic 180° turn headworks.

Water fittings with ceramic headwork offer quick and precise adjustment and a long service life.

Opening/closing function: 1 x 180° turn

Media: Hot/cold water

Temperature range: Maximum 90°C

Max. working pressure: 10 bar / 147 psi

Test pressure: 1 x working pressure

Materials with media contact

Metals: Brass

Sealing: EPDM

Plastics: POM

Lubricant: Silicone based

Ceramics: Al-oxyd 96%

Ordering information

Ceramic headwork

No. 1976000

Flow Chart

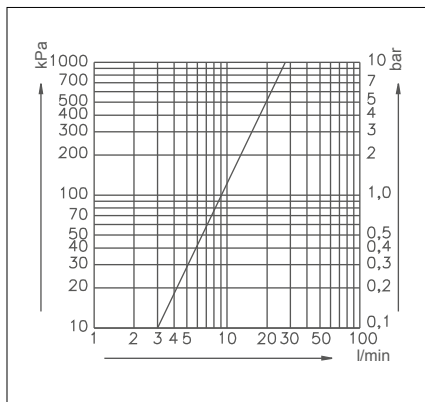

Ceramic headwork

HEADWORK - WRIST ACTION LEVER HANDLE

Specifications

BROEN-LAB UniFlex™ water fittings with wrist action lever are delivered with a ceramic 90° turn headwork.

Opening/closing function: 90° turn

Media: Hot/cold water

Temperature range: Maximum 90°C

Max. working pressure: 10 bar / 147 psi

Test pressure: 1 x working pressure

Materials with media contact

Metals: Brass

Sealing: EPDM

Plastics: POM

Lubricant: Silicone based

Ceramics: Al-oxyd 96%

Ordering information

LEFT TURN CLOSING

Ceramic headwork

No. 19764000

RIGHT TURN CLOSING

Ceramic headwork

No. 19765000



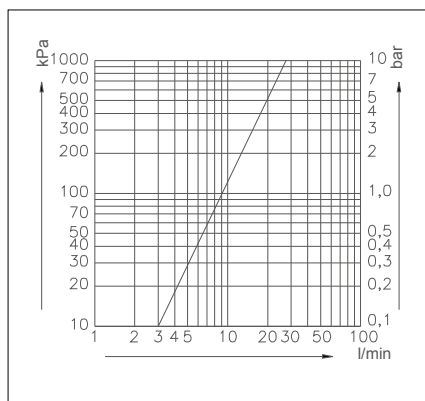





Flow Chart

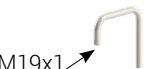

Ceramic headwork

ACCESSORIES

M19x1 - Nozzles and aerators for spouts

 M19x1	Removable nozzle Polypropylene	Fixed nozzle Polypropylene	Aerator	Removable nozzle metal	Fixed nozzle metal
Adaptor	 M19x1 G1/2"	No adaptor needed	 M19x1 M22x1	 M19x1 G1/2"	No adaptor needed
	2539 003 1001		2539 005 1001	2539 007 1001	
Nozzle/Aerator	 G1/2"	 M19x1	 M22	 G1/2"	 M19x1
	2539 004 1001	2539 010 1001	2539 006 1001	2539 008 1001	2539 009 1001

G3/8" - Nozzles and aerators for valves and outlets

 G3/8"	Removable nozzle Polypropylene	Fixed nozzle Polypropylene	Aerator	Removable nozzle metal	Fixed nozzle metal
Adaptor	 G3/8" G1/2"	No adaptor needed	 G3/8" M22x1	 G3/8" G1/2"	No adaptor needed
	2539 048 1001		2539 064 1001	2539 043 1001	
Nozzle/Aerator	 G1/2"	 G3/8"	 M22	 G1/2"	 G3/8"
	2539 004 1001	2539 040 1001	2539 006 1001 Aerator with integrated flow restrictor 5 l/min: 2539 045 1001	2539 008 1001	2539 042 1001

ACCESSORIES

Illustration	Description	BROEN-LAB item no.
	Mounting set for G1/2" connection Mounting set for M30x1.5 connection	19 141 000 19 190 000
	1/2" NPT inlet with female BROEN-LAB UniFlex™ connection (incl. O-ring) L = 30mm L = 60mm L = 90mm	15 502 33V Code -05 15 274 54V Code -14 15 502 46V Code -18
	ISO 228/1-G1/2" inlet with female BROEN-LAB UniFlex™ connection (incl. o-ring) L = 30mm L = 60mm L = 90mm	15 501 33 Code -02 15 501 12 Code -08 15 501 46 Code -17
	Threaded inlet pipe M30x1.5 L = 30mm L = 60mm L = 90mm	19 190 03 Code -50 19 190 02 Code -52 19 190 04 Code -54
	Wall flange socket (WFS) (for exposed piping)	02 101 300G
	Wall flange socket (WFS) (for built-in installation)	02 101 310
	Cover flange for 02 101 310	14 923 04G
	Metal handle with media indication according to EN 13792	19 160 149 10 XX Replace XX with the media on page 39
	Wrist action lever	See sparepart catalogue 99B0108

ACCESSORIES

Illustration	Description	BROEN-LAB item no.
	<p>Water jet filter pump (inlet: union nut G3/4, adapter to female G1/2 is included)</p>	<p>19 199 009</p>
	<p>Flange (wall thickness 0-20mm)</p>	<p>1521 057G</p>
	<p>Flange (wall thickness 20-40mm)</p>	<p>1521 178G</p>
	<p>Nut (wall thickness 0-20mm)</p>	<p>1521 036</p>
	<p>Nut (wall thickness 20-40mm)</p>	<p>1521 054</p>
	<p>Straight Rear Wall Connection (RWC)</p>	<p>1521 088</p>
	<p>90° Rear Wall Connection (RWC)</p>	<p>1521 052</p>
	<p>Rear wall support plate</p>	<p>1521 092</p>

ORDERING INFORMATION



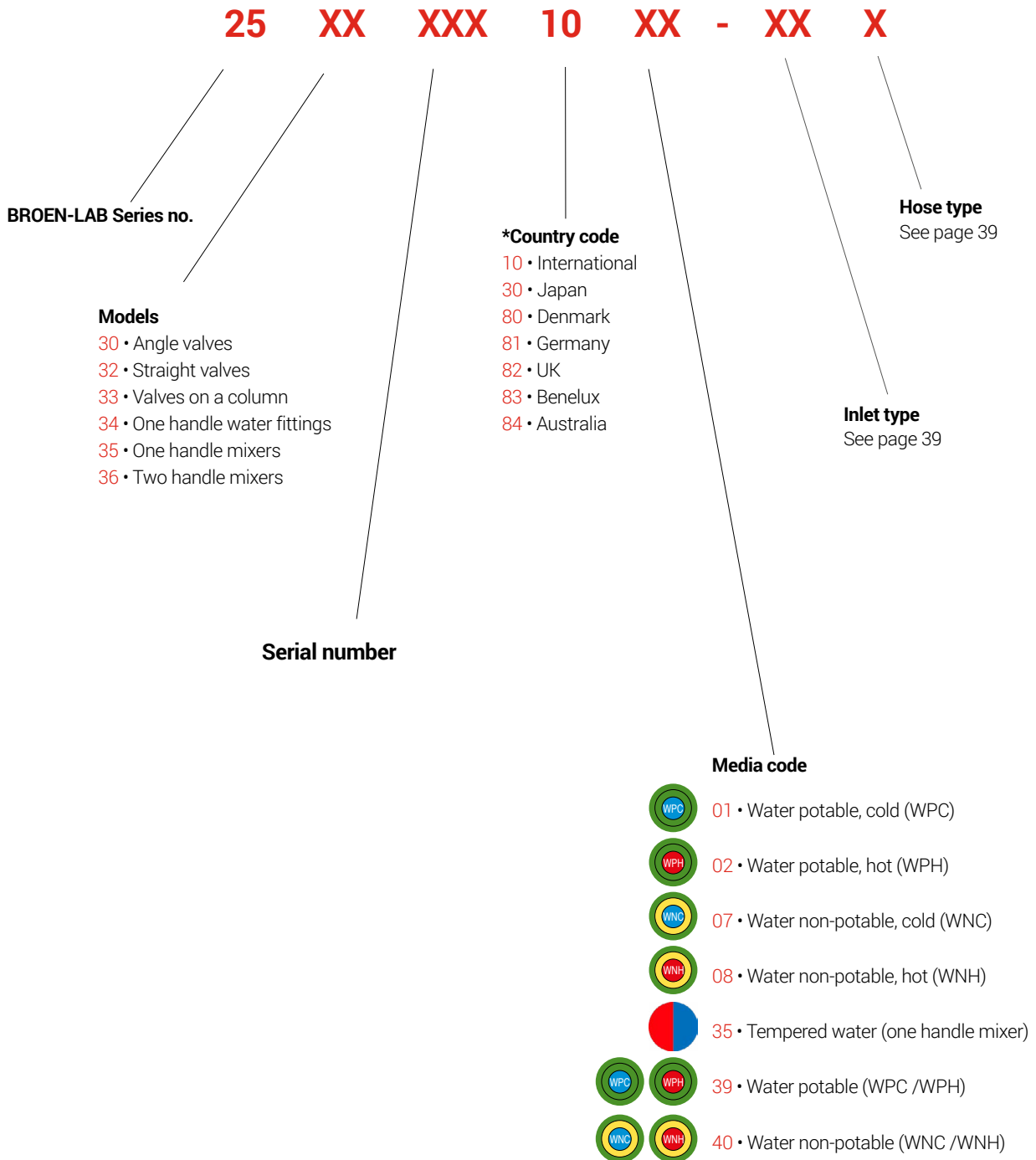

Generally, item number for BROEN-LAB UniFlex™ fittings has the following structure:

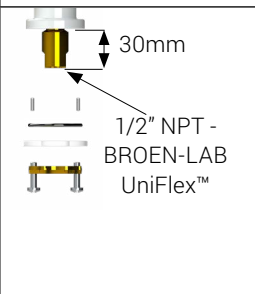
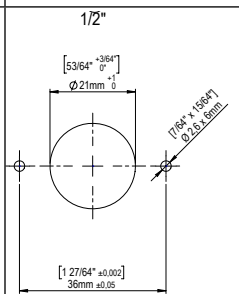
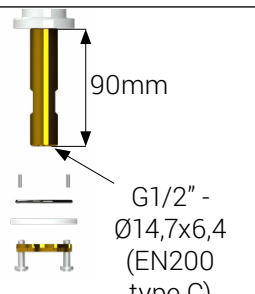
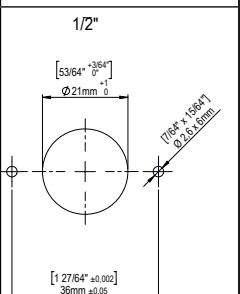
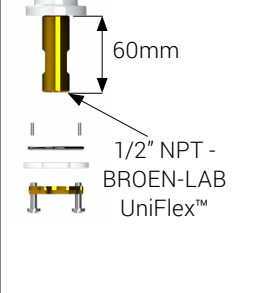
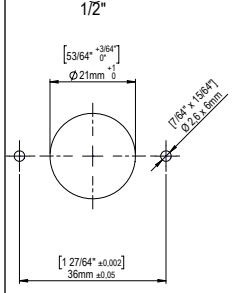
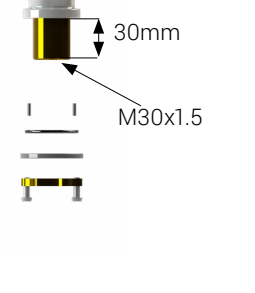
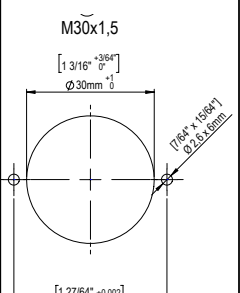
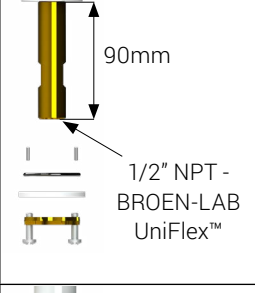
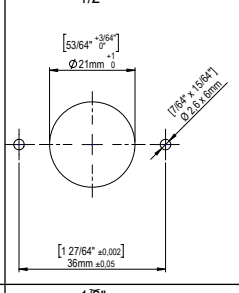
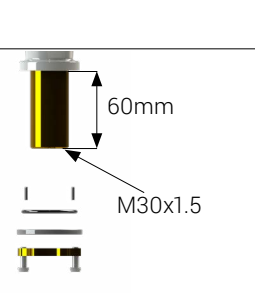
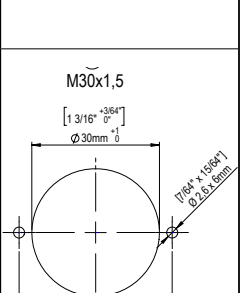
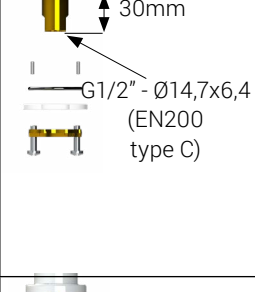
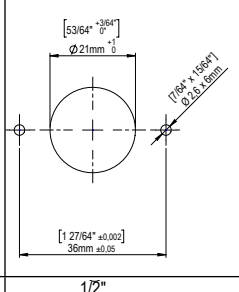
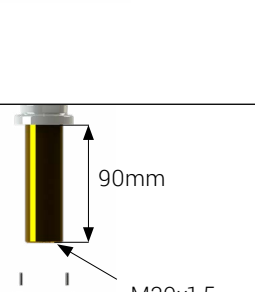
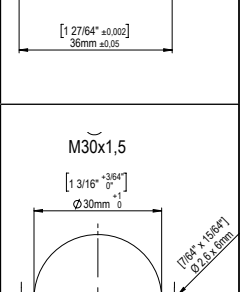
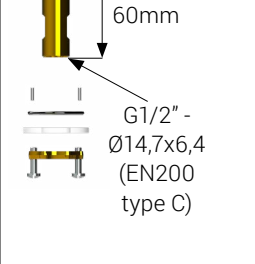
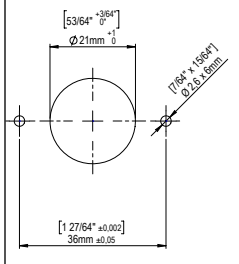

For other configuration options please contact your local BROEN-LAB representative.

ORDERING INFORMATION

Number	Inlet design	Drilling template	Number	Inlet design	Drilling template
-05	 <p>30mm 1/2" NPT - BROEN-LAB UniFlex™</p>	 <p>1/2" [53/64" ^{+3/64"}/_{0"}] Ø21mm ⁺¹/₀ [1 27/64" ^{+0.002}/₀] 36mm ^{+0.05}/₀ [7/64" ^{+1/64"}/₀] Ø 2.5 x 6mm</p>	-17	 <p>90mm G1/2" - Ø14,7x6,4 (EN200 type C)</p>	 <p>1/2" [53/64" ^{+3/64"}/_{0"}] Ø21mm ⁺¹/₀ [1 27/64" ^{+0.002}/₀] 36mm ^{+0.05}/₀ [7/64" ^{+1/64"}/₀] Ø 2.5 x 6mm</p>
-14	 <p>60mm 1/2" NPT - BROEN-LAB UniFlex™</p>	 <p>1/2" [53/64" ^{+3/64"}/_{0"}] Ø21mm ⁺¹/₀ [1 27/64" ^{+0.002}/₀] 36mm ^{+0.05}/₀ [7/64" ^{+1/64"}/₀] Ø 2.5 x 6mm</p>	-50	 <p>30mm M30x1.5</p>	 <p>M30x1,5 [1 3/16" ^{+3/64"}/_{0"}] Ø30mm ⁺⁰/₀ [1 27/64" ^{+0.002}/₀] 36mm ^{+0.05}/₀ [7/64" ^{+1/64"}/₀] Ø 2.5 x 6mm</p>
-18	 <p>90mm 1/2" NPT - BROEN-LAB UniFlex™</p>	 <p>1/2" [53/64" ^{+3/64"}/_{0"}] Ø21mm ⁺¹/₀ [1 27/64" ^{+0.002}/₀] 36mm ^{+0.05}/₀ [7/64" ^{+1/64"}/₀] Ø 2.5 x 6mm</p>	-52	 <p>60mm M30x1.5</p>	 <p>M30x1,5 [1 3/16" ^{+3/64"}/_{0"}] Ø30mm ⁺⁰/₀ [1 27/64" ^{+0.002}/₀] 36mm ^{+0.05}/₀ [7/64" ^{+1/64"}/₀] Ø 2.5 x 6mm</p>
-02	 <p>30mm G1/2" - Ø14,7x6,4 (EN200 type C)</p>	 <p>1/2" [53/64" ^{+3/64"}/_{0"}] Ø21mm ⁺¹/₀ [1 27/64" ^{+0.002}/₀] 36mm ^{+0.05}/₀ [7/64" ^{+1/64"}/₀] Ø 2.5 x 6mm</p>	-54	 <p>90mm M30x1.5</p>	 <p>M30x1,5 [1 3/16" ^{+3/64"}/_{0"}] Ø30mm ⁺⁰/₀ [1 27/64" ^{+0.002}/₀] 36mm ^{+0.05}/₀ [7/64" ^{+1/64"}/₀] Ø 2.5 x 6mm</p>
-08	 <p>60mm G1/2" - Ø14,7x6,4 (EN200 type C)</p>	 <p>1/2" [53/64" ^{+3/64"}/_{0"}] Ø21mm ⁺¹/₀ [1 27/64" ^{+0.002}/₀] 36mm ^{+0.05}/₀ [7/64" ^{+1/64"}/₀] Ø 2.5 x 6mm</p>			

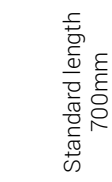
 <p>Standard length 700mm</p>	 <p>Standard length 310mm</p>	 <p>Standard length 700mm</p>	 <p>Standard length 700mm</p>	 <p>Standard length 700mm</p>
No pipe/hose No code	OD 10 mm Code "B"	CU-pipes Code "C"	G3/8" Union nut Code "D"	G 1/2" Union nut Code "E"
				OD 15 mm Code "H"

HEADQUARTER

BROEN-LAB A/S

Drejervaenget 2
5610 Assens
Denmark

Tel. +45 6376 6376
Fax +45 6471 2476

lab@broen-lab.com
broen-lab.com

INTERNATIONAL OFFICES

BROEN-LAB Ltd.

Tel. +44 121 522 4515
Fax +44 121 522 4535

lab@broen-lab.com
broen-lab.com

BROEN-LAB Singapore Pte. Ltd.

25 International Business Park
#04-60A German Centre
Singapore 609916

Tel. +65 6298 0662
Fax +65 62 98 04 68

lab@broen-lab.com
broen-lab.com

BROEN-LAB GmbH

Tel. +45 6376 6376
Fax +45 6471 2476

lab@broen-lab.com
broen-lab.com

BROEN-LAB Sverige AB

Tel. +45 6376 6376
Fax +45 6471 2476

lab@broen-lab.com
broen-lab.com

BROEN-LAB Inc.

15 Constitution Drive
Suite 122
NH 03110
Bedford
USA

Tel. +1 603 310 5089

lab@broen-lab.com
broen-lab.com

BROEN-LAB develops, manufactures and sells Laboratory Fittings, Emergency Shower Systems and Eye Wash Systems into a broad spectrum of laboratories and industrial locations; sectors include Pharmaceutical, Food&Beverage and Academia. Our expertise and product quality ensure optimal solutions compliant to all relevant international norms setting new standards in risk mitigation in modern research and development facilities.

BROEN-LAB offers solutions that ensure the functionality, compliance, hygiene, durability and safety are of the highest priority. For more than 50 years our products have been integrated into a wide variety of workplaces, laboratories, hospitals and industrial locations, with features that are assessed and designed to be flexible, durable and compliant offering a broad range of options tailored to each location. This inherent design integrity provides confidence in the solution adopted wherever in the world these are applied.

BROEN-LAB is a collaboration partner in the design and layout of your next laboratory and it's integrated safety.



BROEN-LAB A/S ISO 9001 certification

In September 1991 BROEN-LAB A/S was certified according to ISO 9001 as one of the first Danish companies. The certification was carried out by Bureau Veritas, Denmark, for our Danish site in Assens.

The quality management system of BROEN-LAB A/S now complies with detailed specifications laid down by the internationally acknowledged EN ISO 9001:2015. This certification will further contribute to reputation for quality and reliability of BROEN-LAB A/S.

BROEN-LAB A/S ISO 14001:2015 certification

In December 2022 we got certified according to ISO 14001 in Environmental certification. The new certification was carried out by Bureau Veritas, Denmark, for Danish site in Assens.

The Environment ISO14001 management system of BROEN-LAB A/S is included in internationally acknowledged EN ISO 9001:2015. Both certifications furthermore contribute to reputation for quality and reliability of BROEN-LAB A/S.